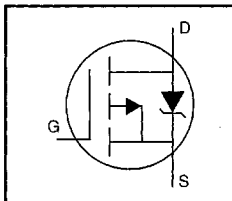


## HEXFET® Power MOSFET

- Dynamic  $dv/dt$  Rating
- Repetitive Avalanche Rated
- P-Channel
- Fast Switching
- Ease of Paralleling
- Simple Drive Requirements



$$V_{DSS} = -200V$$

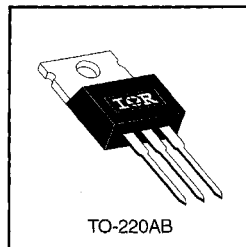
$$R_{DS(on)} = 0.50\Omega$$

$$I_D = -11A$$

### Description

Third Generation HEXFETs from International Rectifier provide the designer with the best combination of fast switching, ruggedized device design, low on-resistance and cost-effectiveness.

The TO-220 package is universally preferred for all commercial-industrial applications at power dissipation levels to approximately 50 watts. The low thermal resistance and low package cost of the TO-220 contribute to its wide acceptance throughout the industry.



TO-220AB

 DATA  
SHEETS

### Absolute Maximum Ratings

Parameter	Max.	Units
$I_D$ @ $T_C = 25^\circ C$	-11	A
$I_D$ @ $T_C = 100^\circ C$	-6.8	
$I_{DM}$	-44	
$P_D$ @ $T_C = 25^\circ C$	125	W
	1.0	W/ $^\circ C$
$V_{GS}$	$\pm 20$	V
$E_{AS}$	700	mJ
$I_{AR}$	-11	A
$E_{AR}$	13	mJ
$dv/dt$	-5.0	V/ns
$T_J$	-55 to +150	$^\circ C$
$T_{STG}$		
	300 (1.6mm from case)	
	10 lbf•in (1.1 N•m)	

### Thermal Resistance

Parameter	Min.	Typ.	Max.	Units
$R_{\theta JC}$	—	—	1.0	$^\circ C/W$
$R_{\theta CS}$	—	0.50	—	
$R_{\theta JA}$	—	—	62	

## Electrical Characteristics @ T<sub>J</sub> = 25°C (unless otherwise specified)

	Parameter	Min.	Typ.	Max.	Units	Test Conditions
V <sub>(BR)DSS</sub>	Drain-to-Source Breakdown Voltage	-200	—	—	V	V <sub>GS</sub> =0V, I <sub>D</sub> =-250μA
ΔV <sub>(BR)DSS</sub> /ΔT <sub>J</sub>	Breakdown Voltage Temp. Coefficient	—	-0.20	—	V/°C	Reference to 25°C, I <sub>D</sub> =-1mA
R <sub>DS(on)</sub>	Static Drain-to-Source On-Resistance	—	—	0.50	Ω	V <sub>GS</sub> =-10V, I <sub>D</sub> =-6.6A ④
V <sub>GS(th)</sub>	Gate Threshold Voltage	-2.0	—	-4.0	V	V <sub>DS</sub> =V <sub>GS</sub> , I <sub>D</sub> =-250μA
g <sub>fs</sub>	Forward Transconductance	4.1	—	—	S	V <sub>DS</sub> =-50V, I <sub>D</sub> =-6.6A ④
I <sub>DSS</sub>	Drain-to-Source Leakage Current	—	—	-100	μA	V <sub>DS</sub> =-200V, V <sub>GS</sub> =0V
		—	—	-500		V <sub>DS</sub> =-160V, V <sub>GS</sub> =0V, T <sub>J</sub> =125°C
I <sub>GSS</sub>	Gate-to-Source Forward Leakage	—	—	-100	nA	V <sub>GS</sub> =-20V
	Gate-to-Source Reverse Leakage	—	—	100		V <sub>GS</sub> =20V
Q <sub>g</sub>	Total Gate Charge	—	—	44	nC	I <sub>D</sub> =-11A
Q <sub>gs</sub>	Gate-to-Source Charge	—	—	7.1		V <sub>DS</sub> =-160V
Q <sub>gd</sub>	Gate-to-Drain ("Miller") Charge	—	—	27		V <sub>GS</sub> =-10V See Fig. 6 and 13 ④
t <sub>d(on)</sub>	Turn-On Delay Time	—	14	—	ns	V <sub>DD</sub> =-100V
t <sub>r</sub>	Rise Time	—	43	—		I <sub>D</sub> =-11A
t <sub>d(off)</sub>	Turn-Off Delay Time	—	39	—		R <sub>G</sub> =9.1Ω
t <sub>f</sub>	Fall Time	—	38	—		R <sub>D</sub> =8.6Ω See Figure 10 ④
L <sub>D</sub>	Internal Drain Inductance	—	4.5	—	nH	Between lead, 6 mm (0.25in.) from package and center of die contact
L <sub>S</sub>	Internal Source Inductance	—	7.5	—		
C <sub>ISS</sub>	Input Capacitance	—	1200	—	pF	V <sub>GS</sub> =0V
C <sub>OSS</sub>	Output Capacitance	—	370	—		V <sub>DS</sub> =-25V
C <sub>rSS</sub>	Reverse Transfer Capacitance	—	81	—		f=1.0MHz See Figure 5

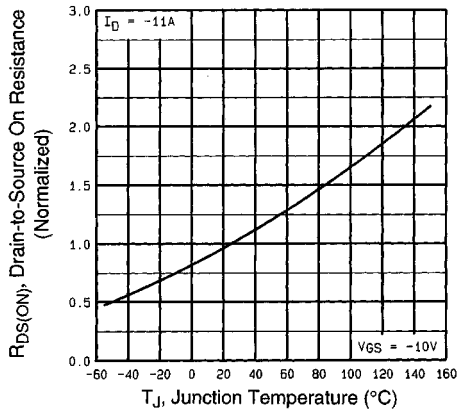
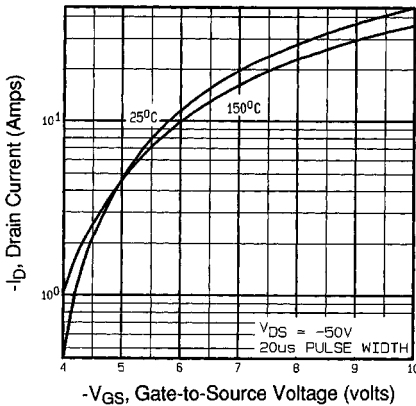
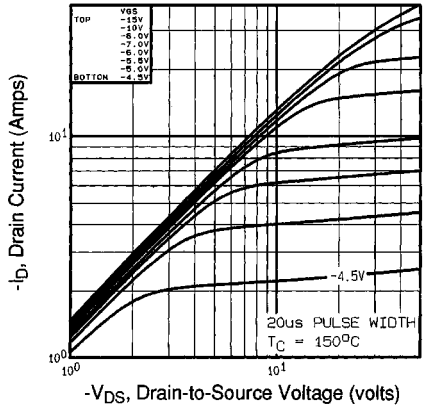
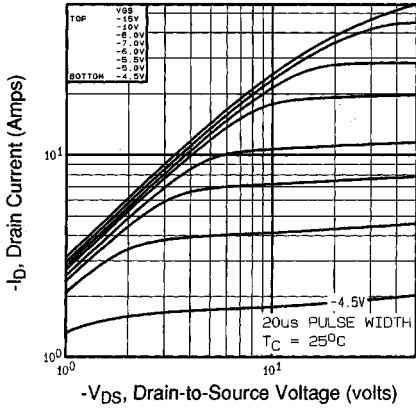


## Source-Drain Ratings and Characteristics

	Parameter	Min.	Typ.	Max.	Units	Test Conditions
I <sub>S</sub>	Continuous Source Current (Body Diode)	—	—	-11	A	MOSFET symbol showing the integral reverse p-n junction diode.
I <sub>SM</sub>	Pulsed Source Current (Body Diode) ①	—	—	-44		
V <sub>SD</sub>	Diode Forward Voltage	—	—	-5.0	V	T <sub>J</sub> =25°C, I <sub>S</sub> =-11A, V <sub>GS</sub> =0V ④
t <sub>rr</sub>	Reverse Recovery Time	—	250	300	ns	T <sub>J</sub> =25°C, I <sub>F</sub> =-11A
Q <sub>rr</sub>	Reverse Recovery Charge	—	2.9	3.6	μC	di/dt=100A/μs ④
t <sub>on</sub>	Forward Turn-On Time	Intrinsic turn-on time is negligible (turn-on is dominated by L <sub>S</sub> +L <sub>D</sub> )				

### Notes:

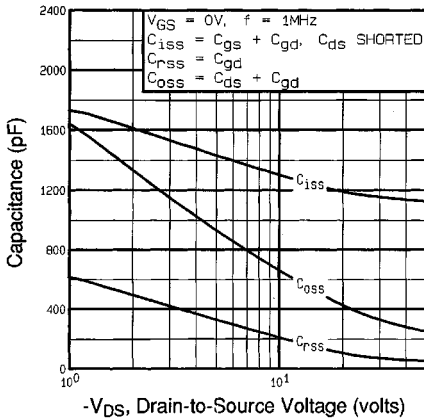
- ① Repetitive rating; pulse width limited by max. junction temperature (See Figure 11)
- ② V<sub>DD</sub>=-50V, starting T<sub>J</sub>=25°C, L=8.7mH R<sub>G</sub>=25Ω, I<sub>AS</sub>=-11A (See Figure 12)
- ③ I<sub>SD</sub>≤-11A, di/dt≤150A/μs, V<sub>DD</sub>≤V<sub>(BR)DSS</sub>, T<sub>J</sub>≤150°C
- ④ Pulse width ≤ 300 μs; duty cycle ≤2%.



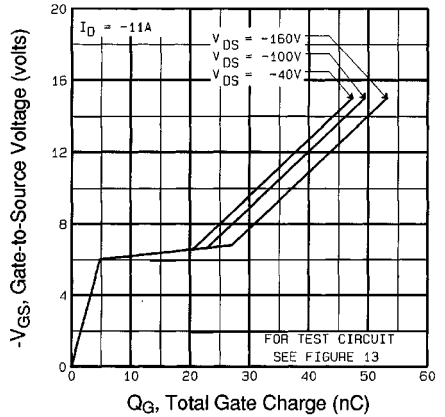
**Fig 3. Typical Transfer Characteristics**

**Fig 4. Normalized On-Resistance Vs. Temperature**

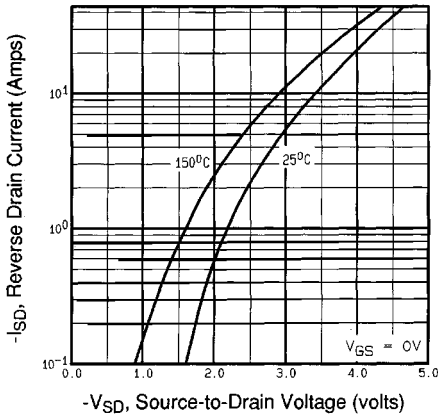
DATA SHEETS



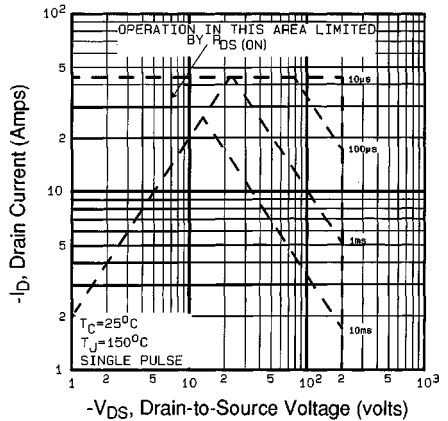
**Fig 5.** Typical Capacitance Vs. Drain-to-Source Voltage



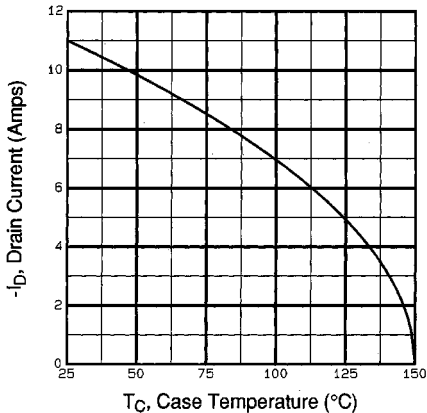
**Fig 6.** Typical Gate Charge Vs. Gate-to-Source Voltage



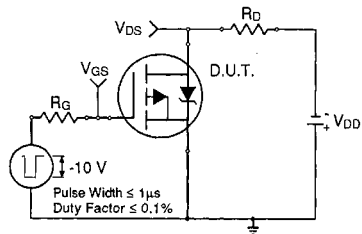
**Fig 7.** Typical Source-Drain Diode Forward Voltage



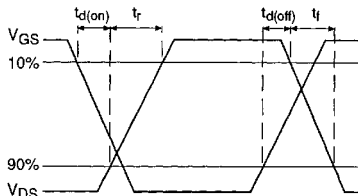
**Fig 8.** Maximum Safe Operating Area



**Fig 9.** Maximum Drain Current Vs. Case Temperature

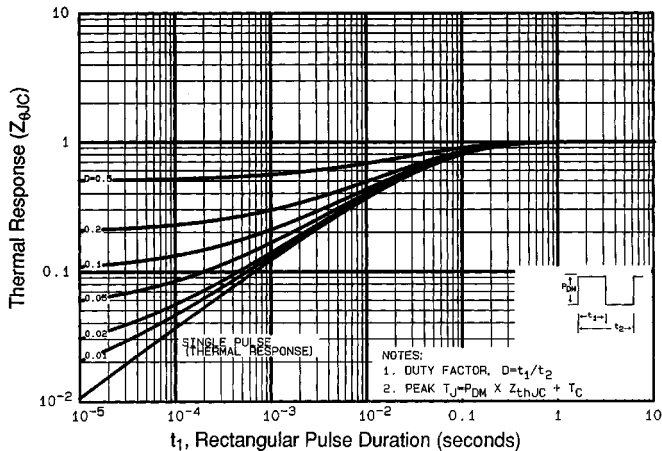


**Fig 10a.** Switching Time Test Circuit

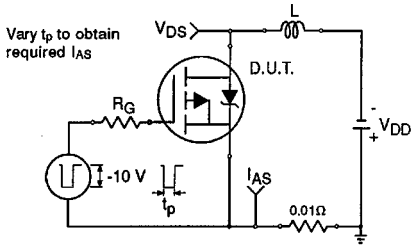


**Fig 10b.** Switching Time Waveforms

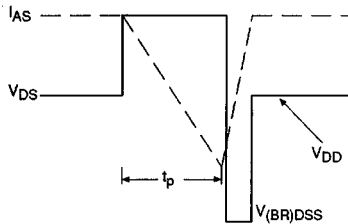
DATA SHEETS



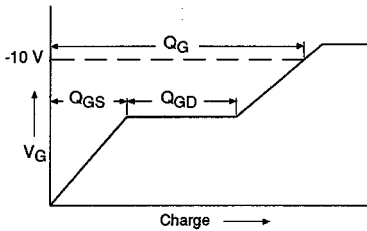
**Fig 11.** Maximum Effective Transient Thermal Impedance, Junction-to-Case



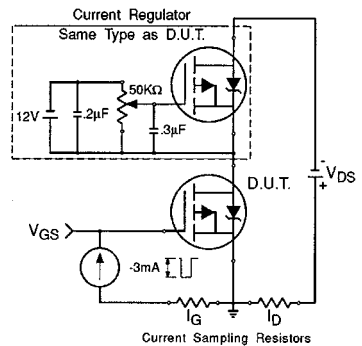
**Fig 12a.** Unclamped Inductive Test Circuit



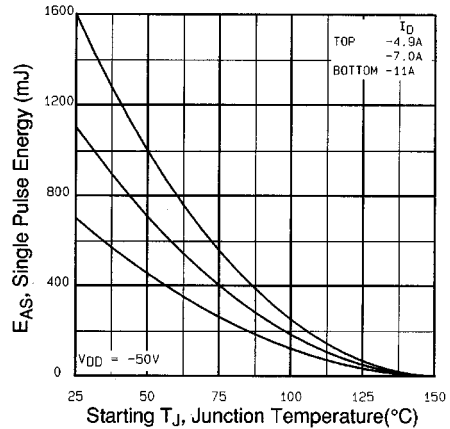
**Fig 12b.** Unclamped Inductive Waveforms



**Fig 13a.** Basic Gate Charge Waveform



**Fig 13b.** Gate Charge Test Circuit



**Fig 12c.** Maximum Avalanche Energy Vs. Drain Current

**Appendix A:** Figure 14, Peak Diode Recovery  $dv/dt$  Test Circuit – See page 1506

**Appendix B:** Package Outline Mechanical Drawing – See page 1509

**Appendix C:** Part Marking Information – See page 1516

**Appendix E:** Optional Leadforms – See page 1525

CAD AUDIO DK - [www.cadaudio.dk](http://www.cadaudio.dk) - [km\\_cad@yahoo.com](mailto:km_cad@yahoo.com)

